

New Bridge F.R.P GRATING

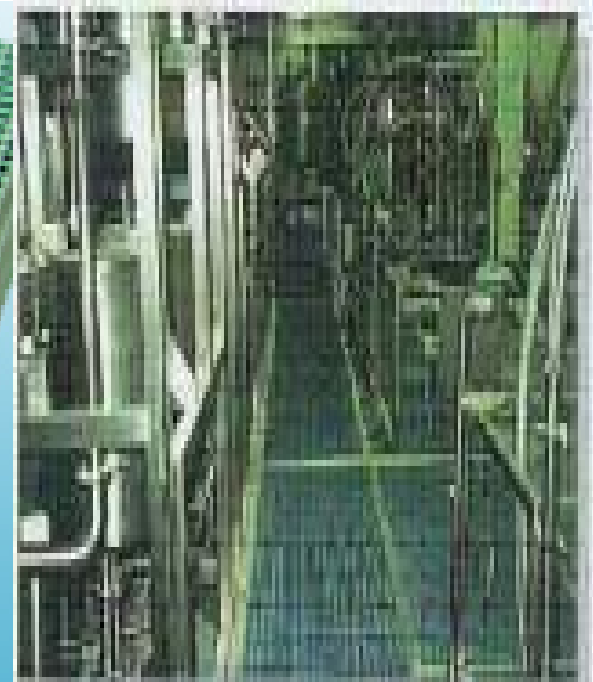
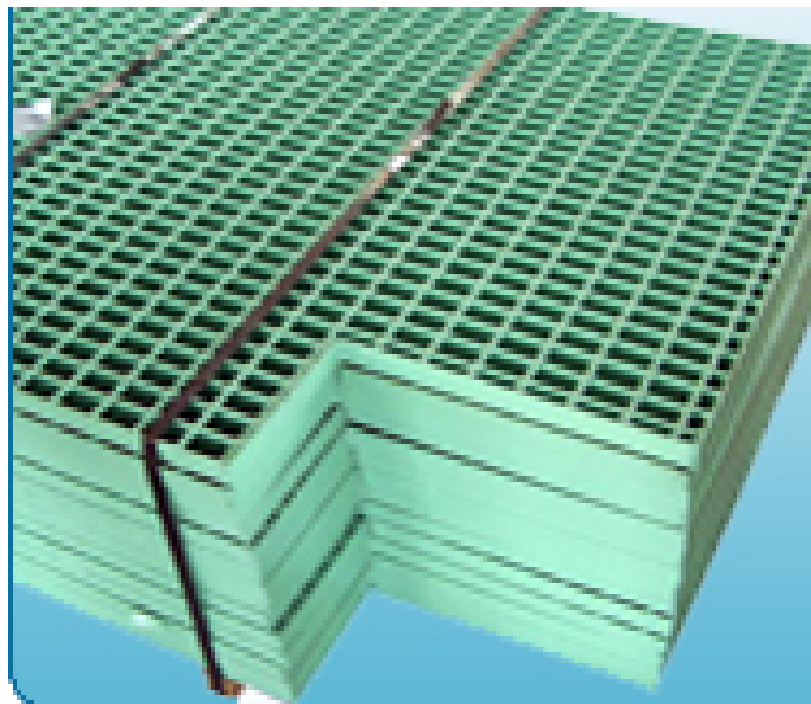
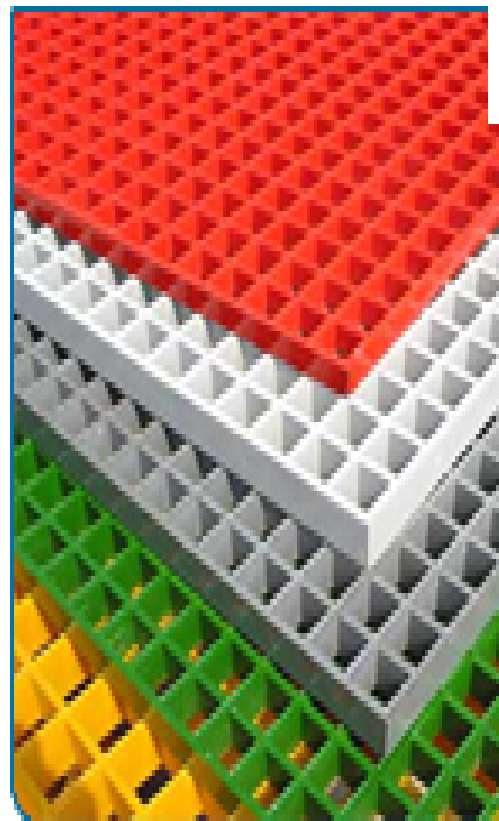
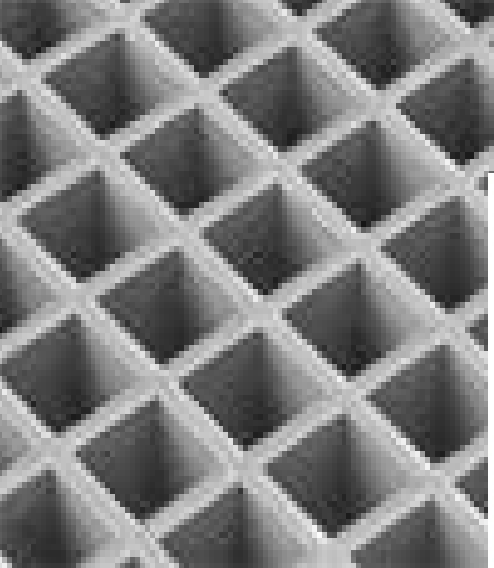

Product Description »

Corrosion resistant, High strength & light weight, Impact resistant Fire retardant, Slip resistant. Anti-fatigue, Non-conductive, non-magnetic, non-sparking, Long service life

Application:

Wastewater Treatment: Cover of trench, Walkways, Drain,
Large capacity vessel, Washing machine, Water channel, Ventilation
valve Stair treads, Flooring

Chemical Plant: Stair trends, Wooden platform, Cover of concrete pool,
Replacement of metal grating.

Textile Plant: Replacement of metal grating, Wooden platform and cover of concrete pool,
Flooring around bleaching, dying area, Floor around pumps and valves area.

F.R.P GRATING

We produce FRP gratings and FRP pultruded grating products.

There are Ortholso and Vinylester gratings.

SHEET SIZES

1220x3000x25mm, 1220x3000x38mm,

1220x3000x50mm, 1220x3000mm x50.8mm,

We can also offer special sheet sizes to meet your requirements.

F.R.P... GRATING LOAD DEFLECTION TABLE

Loading Deflection Table of Molded Gratings in Common Sizes

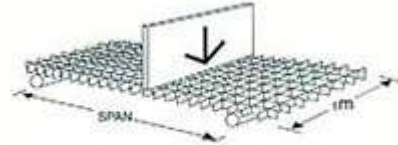
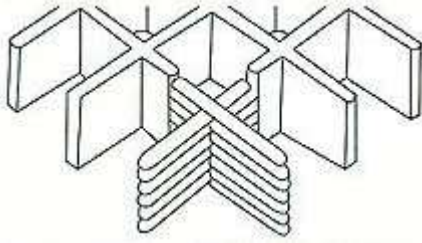

**CONCENTRATED LINE LOAD TABLE
DEFLECTION IN mm**

H25 Mesh size 38*38

	<p style="text-align: center;">Bar thickness(Top/Bottom) 6.4/5.0</p> <p style="text-align: center;">Distance between centers of bearing bars 38</p> <p style="text-align: center;">Open Area 68%</p> <p style="text-align: center;">Weight per Square meter 12.3kg/m²</p>
<p>Standard panel sizes: 1220*4000、1220*3660、 1220*2440、915*3050 Both directions</p>	

Deflection	kg/m						Break point
	SPAN	75	150	300	450	600	
450	0.559	1.146	2.159	3.073	4.115	4.75	3910
600	0.864	1.702	3.505	5.156	6.706	8.179	2924
900	2.896	5.918	12.116	18.44	--	--	1948
1200	5.715	11.633	--	--	--	--	1491

H30 Mesh size 38*38

	<p style="text-align: center;">Bar thickness(Top/Bottom) 6.5/5.0</p> <p style="text-align: center;">Distance between centers of bearing bars 38</p> <p style="text-align: center;">Open Area 68%</p> <p style="text-align: center;">Weight per Square meter 14.6kg/m²</p>
<p>Standard panel sizes: 1220*4000、1220*3660、 1220*2440、915*3050 Both directions</p>	

Deflection	kg/m						Break point
	SPAN	75	150	300	450	750	
300	<0.254	<0.254	0.254	0.508	0.762	1.524	9923.4
450	0.254	0.508	1.016	1.524	2.54	--	4827.6
600	0.508	1.27	2.286	3.556	5.842	--	4112.4
750	1.27	2.54	4.826	7.366	12.446	--	3173.7
900	1.778	3.81	7.62	11.43	--	--	2637.3

H38 Mesh size 38*38

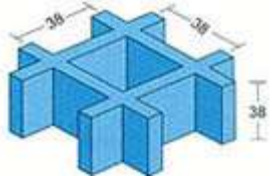

Bar thickness (Top/Bottom) 7.0/5.0
 Distance between centers of beraing bars 38
 Open Area 68%
 Weight per Square meter 19.5kg/m²

Standard panel sizes: 1220*4000, 1220*3660, 1220*2440, 915*3050, 1524*3050, 1254*4000 Both directions

Deflection	kg/m						Break point
	SPAN	75	150	300	450	600	
300	0.279	0.356	0.483	0.61	0.762	0.889	17116
600	0.356	0.66	1.245	1.85	2.464	3.073	8718
900	0.864	1.803	3.683	5.563	7.417	9.296	5817
1200	2.261	4.749	9.677	14.63	19.583	--	3755

H50 Mesh size 50*50

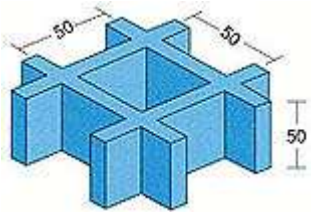

Bar thickness (Top/Bottom) 8.0/6.0
 Distance between centers of beraing bars 50
 Open Area 78%
 Weight per Square meter 23.7kg/m²

Standard panel sizes: 1524*4000, 1220*3660, 1220*2440, 915*3050 Both directions

Deflection	kg/m						Break point
	SPAN	75	150	300	450	600	
300	0.279	0.305	0.406	0.483	0.636	1.041	21727
600	0.356	0.508	0.813	1.128	1.753	3.327	11713
900	0.508	1.118	2.235	3.2	5.156	10.058	7780
1200	0.914	1.93	3.937	5.918	9.957	--	5834

**Loading Deflection Table of Molded Gratings in
Common Sizes**

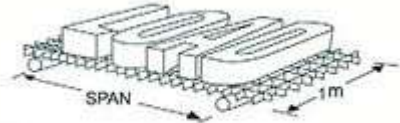

UNIFORM LOAD TABLE DEFLECTION IN mm



CONCENTRATED FULL PANEL LOAD
1220X3660 DEFLECTION IN mm

H25 Mesh size 38*38

Deflection	kg/m ²						
SPAN	240	480	980	1450	2450	3650	4880
450	0.66	1.092	1.93	2.769	4.47	6.579	--
600	1.118	2.108	4.14	6.172	10.211	15.265	--
750	2.667	5.387	10.82	16.28	--	--	--
900	5.537	11.176	21.717	--	--	--	--

Deflection	kg						
SPAN	150	370	750	1120	1500	2200	2980
450	0.254	0.686	1.55	2.159	2.667	4.166	5.232
600	0.734	1.651	3.175	4.623	6.121	9.119	12.116
900	1.778	4.445	8.814	13.157	--	--	--
1200	2.946	7.544	15.062	--	--	--	--

H30 Mesh size 38*38

Deflection	kg/m ²						Break
SPAN	350	500	750	1000	1500	2500	point
300	<0.254	<0.254	<0.254	<0.254	<0.254	0.508	32500.8
450	0.254	0.508	0.762	1.016	1.524	2.286	21661.2
600	1.016	1.524	2.286	2.794	4.318	7.366	12980.8
750	2.54	3.81	5.842	7.62	11.684	--	8296
900	4.572	7.112	10.668	--	--	--	5758.4

Deflection	kg				
SPAN	25	45	100	150	250
600	<0.254	0.254	0.760	1.016	1.778
750	0.254	0.762	1.72	2.032	3.302
900	0.508	0.762	1.778	2.54	4.064
1050	0.762	1.524	2.794	43.18	7.112
1200	1.016	1.778	3.81	5.588	9.398

H38 Mesh size 38*38

Deflection	kg/m ²						
SPAN	240	480	980	1450	2450	3650	4880
300	0.254	0.305	0.381	0.457	0.635	0.838	--
600	0.432	0.813	1.549	2.311	3.835	5.74	--
900	1.702	3.454	6.959	10.465	17.475	--	--
1200	5.969	12.167	24.511	--	--	--	--

Deflection	kg						
SPAN	150	370	750	1120	1500	2200	2980
450	0.203	0.406	0.711	0.889	1.143	1.676	2.21
600	0.356	0.889	1.499	1.905	2.413	3.531	4.267
900	0.61	1.5	2.9	4.14	5.41	7.95	10.566
1200	0.914	2.388	4.699	6.96	9.195	13.665	--

H50 Mesh size 50*50

Deflection	kg/m ²						
SPAN	240	480	980	1450	2450	3650	4880
300	0.254	0.279	0.33	0.381	0.483	0.737	--
600	0.381	0.584	0.965	1.372	2.134	4.115	--
900	1.194	2.108	3.937	5.766	9.449	18.593	--
1200	2.413	4.928	9.957	14.961	--	--	--

Deflection	kg						
SPAN	300	600	900	1500	2200	2980	3700
450	0.254	0.33	0.457	0.711	1.016	1.346	1.7018
600	0.381	0.8636	1.1176	1.524	2.032	2.54	3.1242
900	0.6604	1.2192	1.778	2.8964	4.1915	5.5126	7.564
1200	0.9398	1.8542	2.7432	4.5476	6.8079	9.2711	11.252

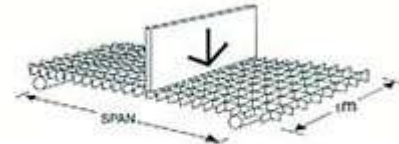
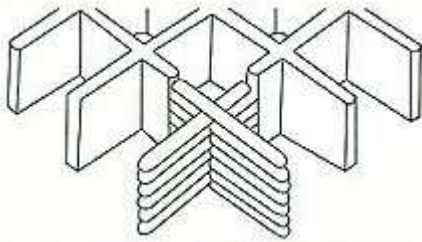

CONCENTRATED LINE LOAD TABLE
DEFLECTION IN mm

H25 Mesh size 25*100

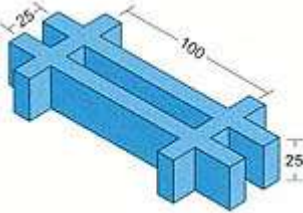

	Bar thickness(Top/Bottom) 7.0/5.5 Distance between centers of bearing bars 25 Open Area 67% Weight per Square meter 13.0kg/m ²
Standard panel sizes: 1007*3007 Width direction	

Deflection	kg/m						Break point
	SPAN	75	150	300	450	600	
300	0.33	0.483	0.737	0.991	1.27	1.52	9442
600	0.864	1.727	3.454	5.182	6.909	8.636	4305
750	1.397	2.718	5.105	7.163	9.55	11.938	3589
900	2.413	4.724	8.814	12.369	16.51	20.625	3216

H25 Mesh size 25*100 Heavy Duty

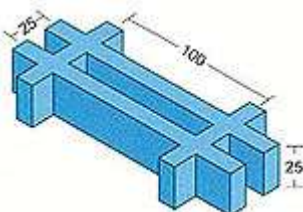

	Bar thickness(Top/Bottom) 9.5/8.0 Distance between centers of bearing bars 25 Open Area 52% Weight per Square meter 19.5kg/m ²
Standard panel sizes: 1220*3660 Width direction	

Deflection	kg/m						Break point
	SPAN	75	150	300	450	600	
300	<0.254	0.254	0.762	1.016	1.27	1.524	10057.5
450	0.508	0.762	1.778	2.54	3.302	4.318	7263.75
600	0.762	1.778	3.556	5.08	6.858	--	5773.75
750	1.524	3.048	6.096	9.144	11.938	--	4842.5
900	2.286	4.826	9.65	--	--	--	4172
1050	3.556	7.112	--	--	--	--	3687.75
1200	5.08	10.16	--	--	--	--	3501.50

H38 Mesh size 38*152

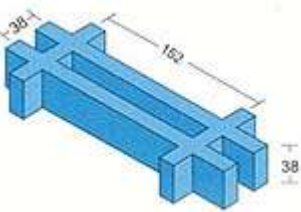

Bar thickness (Top/Bottom) 8.0/6.0

Distance between centers of bearing bars 38

Open Area 67%

Weight per Square meter 15.92kg/m²

Standard panel sizes: 1220*3660 Length direction, Width direction

Deflection	kg/m						Break point
	SPAN	75	150	300	450	600	
300	<0.254	<0.254	0.254	0.508	0.508	0.762	12627.75
450	<0.254	0.254	0.762	1.016	1.524	1.778	9945.75
600	0.254	0.762	1.524	2.286	3.048	3.81	8232.25
750	0.762	1.27	2.794	4.064	5.334	6.604	7040.25
900	1.016	2.286	4.318	6.604	8.636	10.92	6146.25
1050	1.524	3.302	6.604	9.906	--	--	5438.5
1200	2.286	4.826	9.652	--	--	--	5140.5

H20 Mesh size 38*38

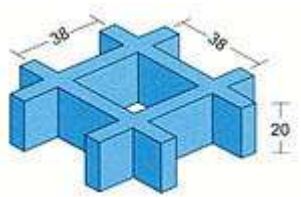

Bar thickness (Top/Bottom) 6.0/5.0

Distance between centers of bearing bars 38

Open Area 65%

Weight per Square meter 9.8kg/m²

Standard panel sizes: 1220*4000, 1220*3660, 1220*2440, 915*3050 Both directions

Deflection	kg/m					Break point
	SPAN	75	150	300	450	
300	0.254	0.508	1.016	1.524	2.54	4470
450	0.762	1.524	3.302	4.826	8.128	2980
600	1.778	3.81	7.62	11.176	--	2235
750	2.794	5.588	11.43	--	--	1788
900	5.334	10.668	--	--	--	1490

Loading Deflection Table of Molded Gratings in Common Sizes

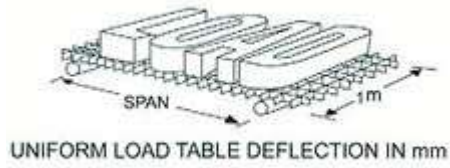

H25 Mesh size 25*100

Deflection	kg/m ²						
SPAN	240	480	980	1450	2450	3650	4880
300	0.279	0.381	0.533	0.711	1.041	--	1.905
600	0.914	1.854	3.683	5.537	9.22	--	18.466
900	3.632	6.6	12.572	18.542	--	--	--
1050	8.007	14.884	--	--	--	--	--

Deflection	kg						
SPAN	150	370	750	1120	1500	2200	2980
450	0.279	0.686	1.448	2.209	2.718	4.191	5.41
600	0.711	1.524	3.531	4.623	6.02	9.22	12.294
900	1.626	3.962	7.823	11.811	--	--	--
1200	--	--	--	--	--	--	--

H25 Mesh size 25*100

Deflection	kg/m ²						Break
SPAN	250	350	500	750	1000	1500	point
300	<0.254	<0.254	<0.254	0.254	0.508	0.508	32940
450	0.508	0.508	0.752	1.27	1.524	2.286	18910
600	1.016	1.27	2.032	3.302	4.318	6.35	15860
750	2.286	3.048	4.572	7.112	9.398	--	12688
900	4.572	5.842	8.89	--	--	--	9110.96
1050	7.874	10.16	--	--	--	--	6900.32
1200	12.7	--	--	--	--	--	5734

Deflection	kg						
SPAN	25	45	100	150	250	450	1000
250	<0.254	<0.254	0.254	0.508	0.762	1.27	2.54
400	<0.254	0.254	0.762	1.016	1.524	3.302	6.53
550	0.254	0.508	1.27	1.778	3.048	6.096	12.192
700	0.508	1.106	2.032	3.048	5.08	1016	--
850	0.762	1.524	3.048	4.572	7.62	--	--
1000	1.016	2.032	3.81	5.874	9.652	--	--
1150	1.27	2.54	5.334	7.874	--	--	--

H38 Mesh size 38*152

Deflection	kg/m ²						Break
SPAN	350	450	750	1000	1500	2500	point
300	<0.254	<0.254	<0.254	0.254	0.254	0.508	41358
450	<0.254	0.254	0.508	0.762	1.016	1.778	26962
600	0.508	1.016	1.27	1.778	2.794	4.572	21716
750	1.27	2.032	3.048	4.064	6.35	--	18446.4
900	2.54	4.064	6.096	8.128	12.192	--	13420
1050	4.572	7.112	10.668	--	--	--	10179.68
1200	7.874	11.938	--	--	--	--	8418

Deflection	kg						
SPAN	25	45	100	150	250	450	1000
250	<0.254	<0.254	<0.254	0.254	0.254	0.762	1.27
400	<0.254	0.254	0.508	0.762	1.016	2.032	4.318
550	<0.254	0.254	0.762	1.016	1.778	3.302	6.858
700	0.254	0.508	1.016	1.524	2.54	5.334	10.414
850	0.508	0.762	1.524	2.286	4.064	7.874	--
1000	0.508	1.016	2.286	3.302	5.588	11.176	--
1150	0.762	1.524	3.048	4.572	7.366	--	--

H20 Mesh size 38*38

Deflection	kg/m ²						Break point
	SPAN	350	500	750	1000	1050	
300	<0.254	0.254	0.508	0.508	1.016	1.524	29280
450	1.016	1.524	2.286	3.048	4.572	7.62	12980.8
600	3.084	4.572	7.112	9.398	--	--	7320
750	5.842	8.89	--	--	--	--	4084.8
900	--	--	--	--	--	--	3226.8

Loading Deflection Table of Molded Gratings in Common Sizes

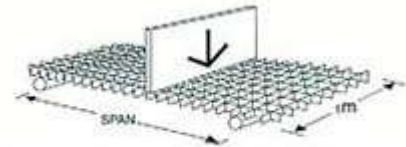
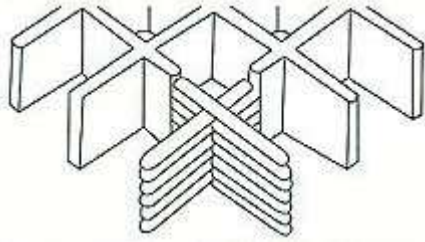

**CONCENTRATED LINE LOAD TABLE
DEFLECTION IN mm**

H38 Mesh size 25*25

	Bar thickness (Top/Bottom)	11.0/9.0
	Distance between centers of bearing bars	25
Open Area	48%	
Weight per Square meter	30.3kg/m ²	
Standard panel sizes: 1220*3660 Length direction		

Deflection	kg/m						Break point
	SPAN	300	750	1500	3000	4500	
300	<.25	<.25	0.254	0.762	1.016	1.524	62580
450	<.25	0.508	1.016	1.778	2.794	3.81	41720
600	0.508	1.016	2.286	4.318	6.604	8.636	30396
750	0.762	2.032	4.318	8.636	--	--	24287
900	1.524	3.556	7.112	--	--	--	20264
1050	2.286	5.588	11.176	--	--	--	17284

H50 Mesh size 25*50

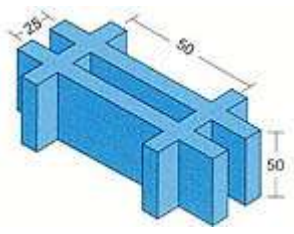

Bar thickness (Top/Bottom) 12.2/9.0

Distance between centers of bearing bars 25

Open Area 48%

Weight per Square meter 41.0kg/m²

Standard panel sizes: 1220*3660 Length direction

Deflection	kg/m						Break point
	SPAN	300	750	1500	3000	4500	
300	<.25	<.25	0.254	0.508	0.508	0.762	69732
450	<.25	0.254	0.508	1.016	1.524	2.032	48574
600	0.254	0.508	1.27	2.286	3.556	4.826	40528
750	0.508	1.27	2.286	4.572	7.112	9.398	32333
900	0.762	20.32	4.064	8.128	12.912	--	26969
1050	1.27	3.302	6.35	12.7	--	--	23095

H38 Mesh size 25*152

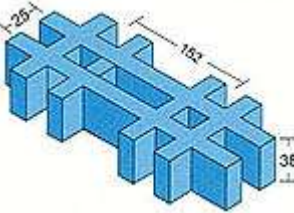

Bar thickness (Top/Bottom) 8.5/6.0

Distance between centers of bearing bars 25

Open Area 63%

Weight per Square meter 22.50kg/m²

Standard panel sizes: 1220*3660, 1220*2440, 915*3050 Length direction

Deflection	kg/m						
	SPAN	150	300	450	750	1000	1500
300	0.33	0.6096	0.889	1.4224	1.9812	2.4638	3.2512
450	0.5588	0.9652	1.3208	1.9812	2.7178	3.3528	4.4704
600	0.7874	1.3208	1.8034	2.794	4.0132	5.1054	7.1882
750	1.0668	1.9558	2.8194	4.572	6.5532	8.4328	12.0904
900	2.0828	2.8956	4.6228	6.477	9.3218	12.0904	--
1050	2.4384	4.3434	6.477	10.7442	--	--	--
1200	2.9464	5.7658	8.5598	--	--	--	--

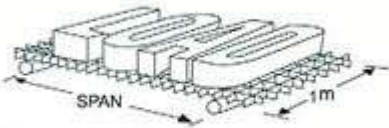

UNIFORM LOAD TABLE DEFLECTION IN mm

deflection	kg/m ²						Break point
	SPAN	1000	2000	2500	3000	3500	
300	<.25	<.25	<.25	<.25	<.25	<.25	409920
450	<.25	0.254	0.508	0.508	0.508	0.762	212280
600	0.508	1.016	1.27	1.524	2.032	2.286	99552
750	1.27	2.794	3.302	4.064	4572	5.334	63440
900	2.54	5.334	6.604	7.874	9.398	10.66	43920
1050	4.826	9.906	12.192	--	--	--	32208

deflection	kg/m ²						Break point
	SPAN	1000	2000	2500	3000	3500	
300	<.25	<.25	<.25	<.25	<.25	<.25	456768
450	<.25	0.254	0.254	0.254	0.254	0.208	212280
600	0.254	0.508	0.762	1.016	1.016	1.27	132736
750	0.762	1.524	1.778	2.286	2.54	2.794	84912
900	1.524	3.048	3.81	4.572	5.33	6.096	42944
1050	2.794	5.588	7.112	8.382	9.906	11.176	42944

deflection	kg/m ²						
	SPAN	250	350	500	750	1500	2500
300	0.0762	0.127	0.1524	0.2286	0.4826	0.7874	1.5748
450	0.1778	0.254	0.33	0.508	0.9906	1.651	3.3274
600	0.33	0.508	0.6858	1.016	2.032	3.3782	7.239
750	0.685	1.016	1.3716	2.0574	4.0894	7.3406	--
900	1.2192	1.8288	2.4384	3.6322	7.2898	12.1412	--
1050	2.3622	3.556	4.9784	7.0612	--	--	--
1200	3.6068	5.4356	7.239	10.8458	--	--	--